

NovoPen[®] (5) User guide

Read this user guide carefully before you use your NovoPen[®] 5 for insulin delivery the first time

Find a quick guide at the back of this manual

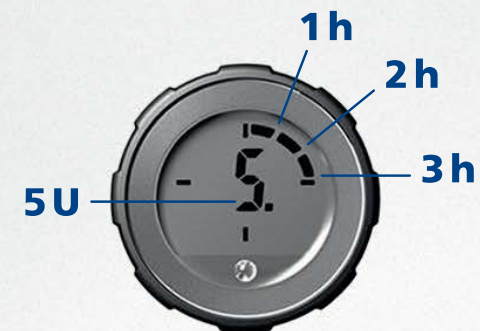

Contents

Overview of pen parts..... Inside cover

Introduction Inside cover

Important notes 1

Prepare the pen for an injection

Insert an insulin cartridge 2

If you use white and cloudy insulin..... 5

Attach a new needle 6

Test the insulin flow (airshot) 8

Select your dose..... 10

Inject your dose..... 12

After your injection..... 14

How to use the dose memory

What is the dose memory? 16

How to read the dose memory..... 17

How to check your last dose..... 18

How to check how much insulin is left 19

If you need more than 60 units..... 20

If you need more units than are left in the pen..... 21

How to replace a used insulin cartridge 22

Special display messages 24

How to care for your pen

Care 26

Cleaning 26

Storage..... 27

Disposal 27

Warranty 28

Technical information 28

For more information go to www.novotrainig.com/novopen5/GB02



NovoPen® 5

Pen

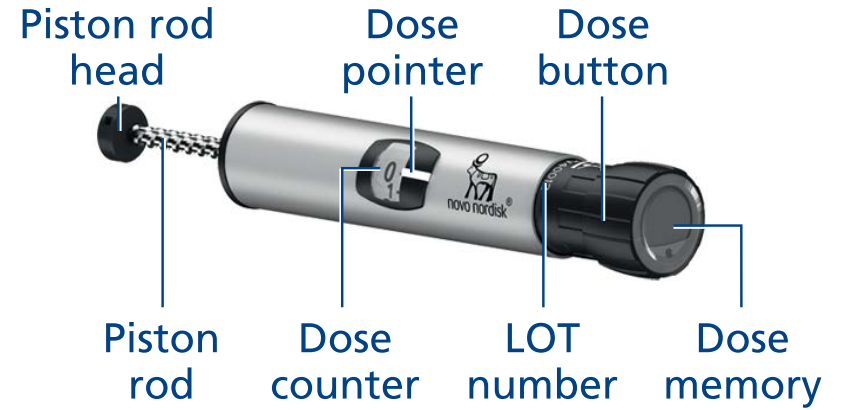
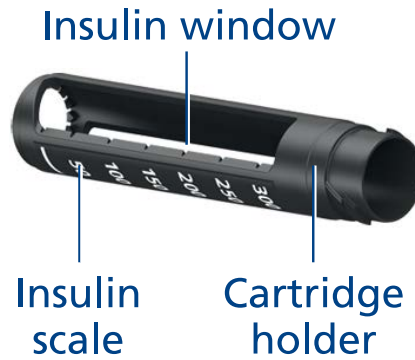

Dose memory



Number of hours since last injection

Number of units last injected

Disposable needle (example)



Outer needle cap



Inner needle cap



Needle



Paper tab

Insulin cartridge (Penfill® cartridge 3 ml)

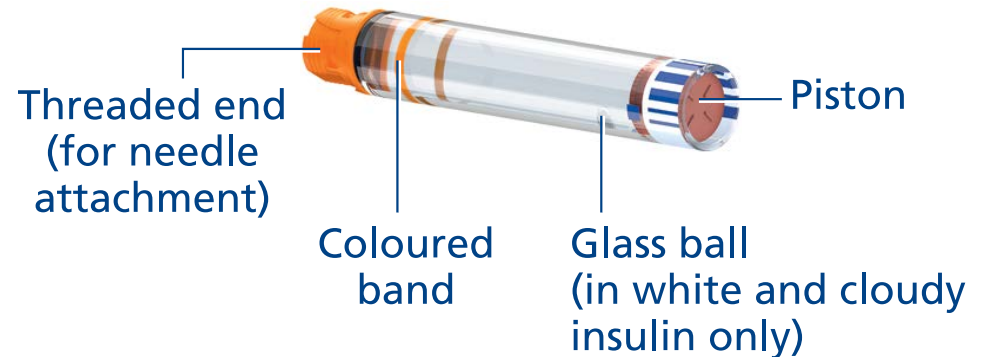

Introduction

Thank you for choosing NovoPen® 5. NovoPen® 5 is a reusable insulin pen with a dose memory function.

You should read this guide carefully before you use your pen – even if you have used NovoPen® 5 or similar Novo Nordisk delivery systems before. It will tell you all you need to know about your pen and how to use it.

NovoPen® 5 is a reusable pen injector designed for single patient use by diabetes patients for the self-injection of insulin. The pen injector uses Penfill® 3 ml cartridges of Novo Nordisk insulin and single use disposable needles (supplied separately). The pen injector allows the user to dial required doses from 1 to 60 units in 1-unit increments.

The pen has a dose memory that helps you remember the number of units you last injected, and the time passed since that injection.

The pen is durable, which means that you can reuse it. When you have used all the insulin in a cartridge, you simply replace it with a new one.

You can get the pen in silver or blue.

Always remember to check the name and colour of the cartridge to make sure it contains the correct type of insulin before every injection.

Mixing up your insulin can have serious medical consequences, it is therefore recommended that if you use two types of insulin, that you discuss how to avoid mix-ups with your HCP.

About this user guide:

Throughout this guide, instructions on how to use your pen are presented step by step. Important information and additional information are clearly marked by the symbols you see below:



Important information

Pay special attention to these notes as they are important for safe use of the pen. If you do not follow the instructions carefully, you may get too little or too much insulin, or no insulin at all.



Additional information



Important notes

- **Do not use NovoPen® 5 without proper training** from your doctor or nurse. Make sure you are confident in making an injection with the pen before you start your treatment with it. Refresh the training at any time by taking a look at the training video online at www.novotraining.com/novopen5/GB02
- **If you are blind or have severe visual problems, do not use NovoPen® 5 without help.** Get help from a person with good eyesight who is trained to use NovoPen® 5.
- **ALWAYS test the insulin flow before each injection.** Do not use the pen if insulin does not squirt from the needle tip when you test the flow. If you do not test the insulin flow, you may get too little insulin, or no insulin at all.
- **If you drop your pen,** check the insulin cartridge for damages, for example cracks. Replace the cartridge with a new one if necessary.
- **If you accidentally twist your pen apart** between injections, it is important to test the flow of insulin before your next injection. You may need to do it several times before insulin squirts from the needle tip. If insulin does not appear, you may get no insulin at all.
- **NovoPen® 5 is designed to be used with Penfill® cartridge 3 ml and NovoFine® or NovoTwist® single-use disposable needles** up to a length of 8 mm.
Novo Nordisk is not responsible for harm due to using NovoPen® 5 with products other than these.
- **Always check the name and colour of the cartridge** to make sure that it contains the type of insulin you need. If you take a wrong type of insulin, your blood sugar level may get too high or too low.
- **Always carry a spare pen,** extra insulin of the same type(s) you use, and new needles with you in case of loss or damage.
- **Never share your pen,** insulin cartridges and needles with other people. They are for your use, only.
- **Always keep your pen,** insulin cartridges and needles **out of sight and reach of others, especially children.**
- **Always keep your pen with you.** Do not leave it in a car or other place where it can get too hot or too cold.
- Caregivers must **be very careful when handling used needles** to reduce the risk of needle sticks and cross-infection.

Insert an insulin cartridge

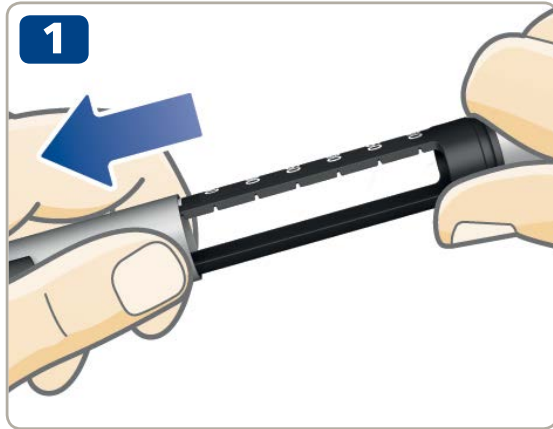

- Pull off the pen cap.



- Twist off the cartridge holder. Put it to one side for later use.

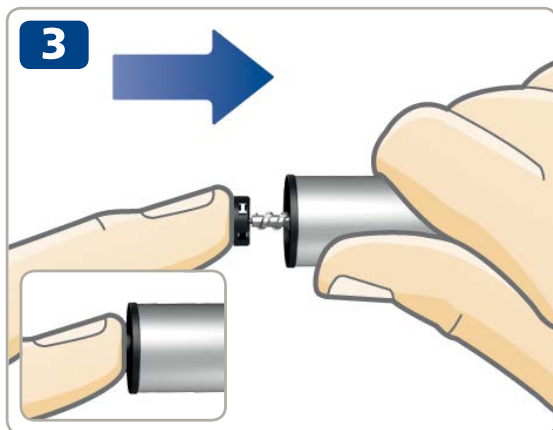

- **The piston rod may stick out** of your pen. If so, **push it completely in** until it stops.

- **i** The piston rod and the piston rod head may be loose and move on their own. This is natural and does not affect the function of the pen.

- Take a new insulin cartridge. Hold the black cartridge holder and let the cartridge slide in with the **threaded end first** as illustrated. The colour of your cartridge may differ from the one shown in the illustration. It depends on the type of insulin you use.



Check the name and colour of the cartridge to make sure that it contains the type of insulin you need. If you take a wrong type of insulin, your blood sugar level may get too high or too low.

Check that the cartridge is not damaged, for example by cracks. See how to do this **in the Penfill® cartridge 3 ml leaflet that comes with the Penfill® cartridge 3 ml package.**

Check that the insulin looks the way it should. The Penfill® cartridge 3 ml leaflet will tell you how your type of insulin should look.

NovoPen® 5 is designed to be used with Penfill® cartridge 3 ml and NovoFine® or NovoTwist® disposable needles up to a length of 8 mm.



5

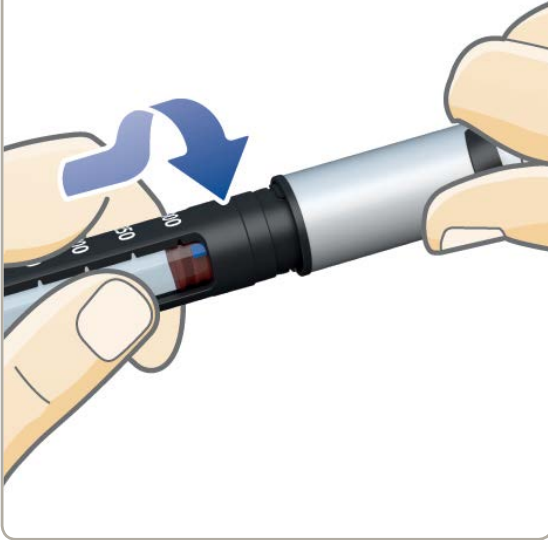

- Twist the cartridge holder back on, as illustrated, until you **hear or feel a click**.

If you use white and cloudy insulin

If you use an insulin cartridge with cloudy-looking insulin (white insulin suspension), **always resuspend this before injection.** See the *Penfill® cartridge 3 ml leaflet* on how to resuspend your type of insulin.

Make sure there is enough space in the cartridge before you resuspend the insulin:
The piston must be **above the white line** on the cartridge holder when you hold the pen as illustrated. This is necessary to allow the glass ball inside the cartridge to move freely to resuspend the insulin.

If the piston is below the white line, replace the insulin cartridge with a new one, see *pages 22-23*.

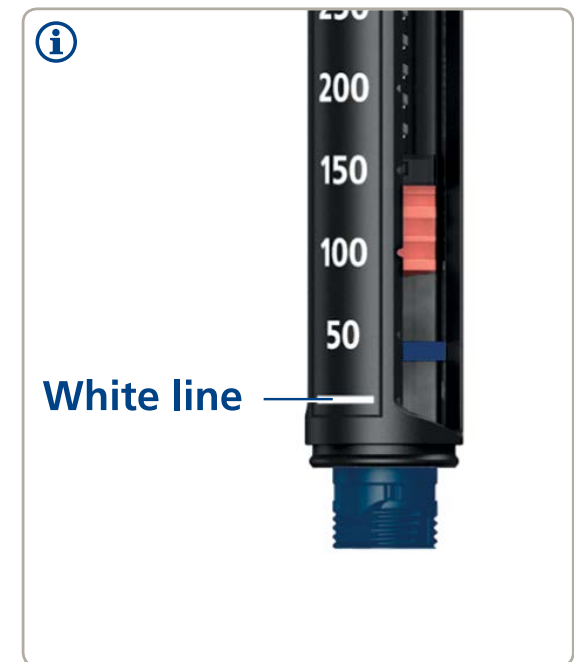

Attach a new needle

1

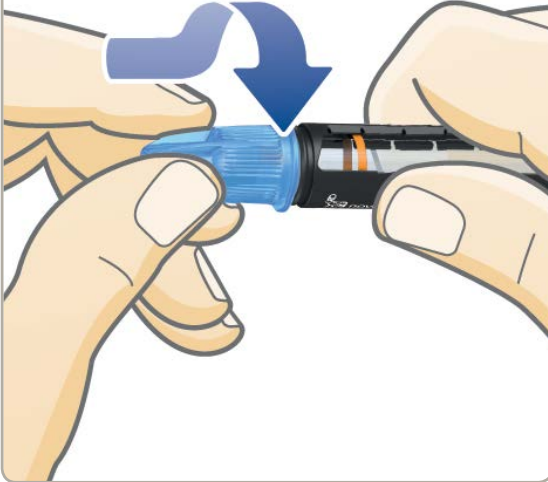

- Take a new needle, and tear off the paper tab.
- Push the needle **straight** onto the pen. **Turn until it is on tight.**

2

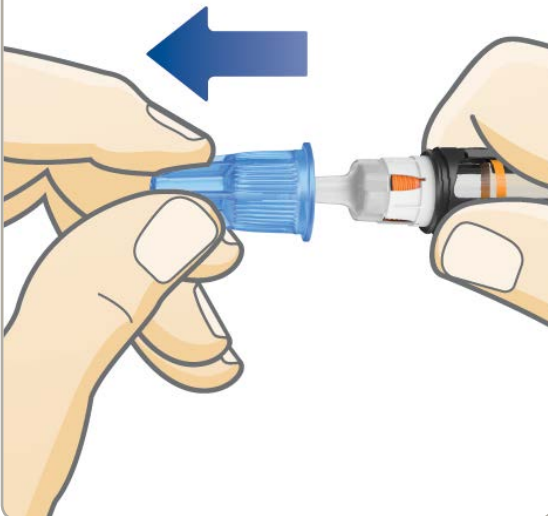

- Pull off the outer needle cap and save it. You will need it after the injection, to safely remove the needle from the pen.



Always use a new needle for each injection. This reduces the risk of blocked needles, contamination, infection and inaccurate dosing.

Never use a bent or damaged needle.

Do not attach a new needle to your pen until you are ready for your next injection.

- Pull off the inner needle cap and throw it away.

A drop of insulin may appear at the needle tip. This is normal, but you must **still test the insulin flow**.

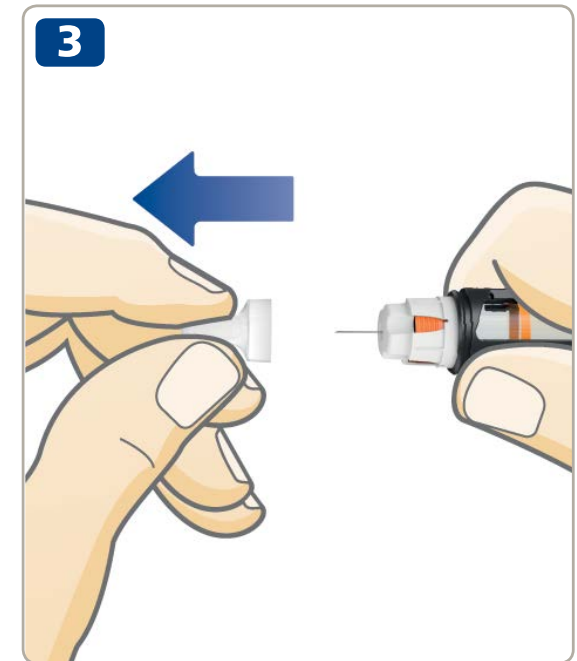

 The needle is covered by two caps. You must remove both caps.

If you forget to remove both caps you will not inject any insulin and you will get high blood sugar level.

 NovoPen® 5 is designed to be used with Penfill® cartridge 3 ml and NovoFine® or NovoTwist® disposable needles up to a length of 8 mm.

Test the insulin flow (airshot)



- **Follow the steps below to test the insulin flow.** This way you will:
 - Remove any gap between the black piston rod head and the orange piston.
 - Remove any air bubbles in the insulin cartridge.
 - Check if the needle is blocked.

This is important to get your full dose.

- **Pull out the dose button,** if it is not already out.

- Turn the dose button to select **2 units.**



Always test the flow every time you inject. Keep testing until insulin squirts from the needle tip. This makes sure that any gap and air bubbles are removed, and that insulin is getting through the needle.

- **Press the dose button** until the dose counter shows “0”. The “0” must line up with the dose pointer.
- Check that insulin squirts from the needle tip.



- Check the insulin window to see that there is no gap between the black piston rod head and the orange piston as shown in illustration A.

If no insulin appears, or if there is a gap in the insulin window as shown in illustration B, repeat the insulin flow test until insulin squirts from the needle tip. If no insulin appears after several attempts, change the needle and test the insulin flow again.

The insulin flow test is complete when you see insulin squirt from the needle tip and when there is no longer a gap between the piston rod head and the piston.

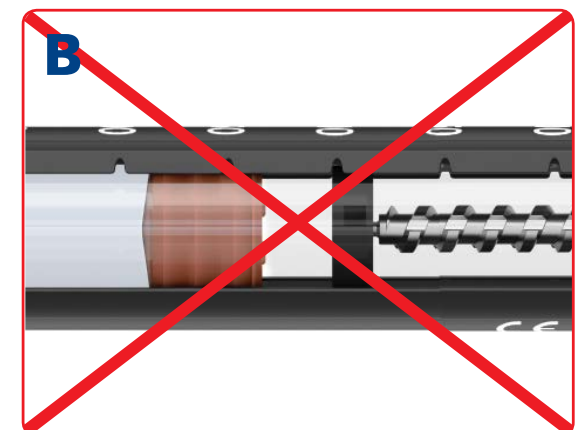
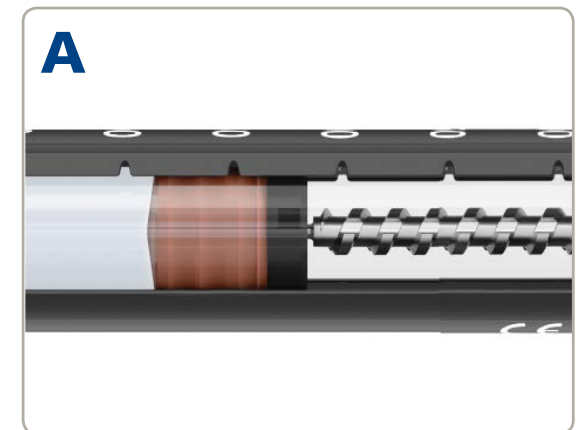

Do not try to inject if no insulin appears. You may not receive any insulin, even though the dose counter may move. This could lead to too high blood sugar (hyperglycaemia).

If insulin does not appear after testing the flow repeatedly, do not use the pen. Contact your supplier to get a new pen.

Select your dose

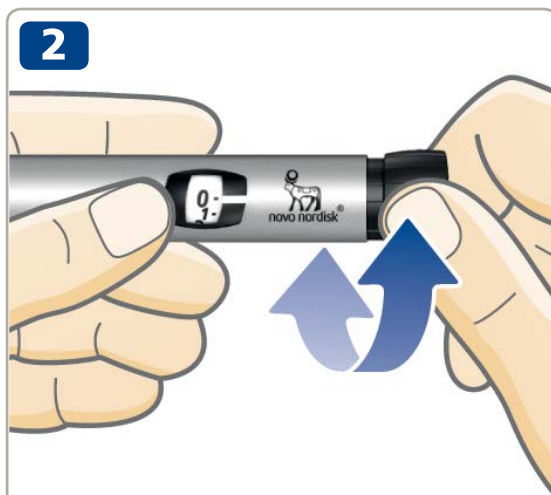
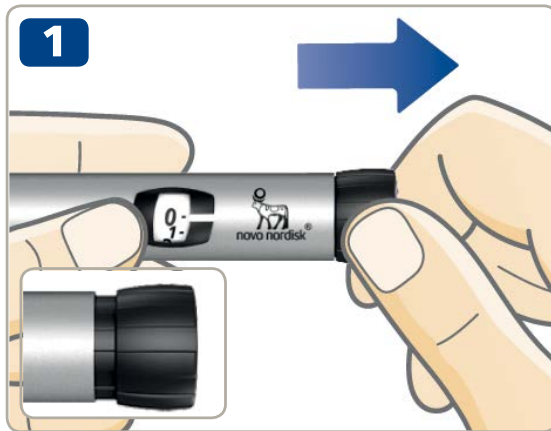

**5 units
selected**



**24 units
selected**

- **Pull out the dose button**, if it is not already out.
- **Make sure the dose counter shows “0” before you start.** The “0” must line up with the dose pointer.
- **Turn the dose button to select the dose you need.** You can turn the dose button **forward or backward**.



The dose button changes the number of units. Only the dose counter and the dose pointer will show how many units you select per dose. You can select up to 60 units per dose.



Always look through the insulin window to **make sure that the insulin in your pen looks the way it should.** The Penfill® cartridge 3 ml leaflet will tell you how your type of insulin should look.

Always use the dose counter and the dose pointer to see how many units you select.

Do not use the insulin scale on the cartridge holder. It only shows approximately how much insulin is left in your pen. Do not count the pen clicks.

If you select and inject a wrong dose, your blood sugar level may get too high or too low.



The dose button should turn easily. Do not force it to turn.

When your pen contains less than 60 units, the dose counter stops at the number of units left. If you need more than 60 units, or if you need more insulin than the units left in your pen, *see pages 20-21.*

Inject your dose



- **Check the name and colour** of the cartridge to make sure that it contains the type of insulin you need. If you take a wrong type of insulin, your blood sugar level may get too high or too low.
- **Insert the needle into your skin** as your doctor or nurse has shown you.
- **Make sure you can see the dose counter.**
- **Press the dose button** until the dose counter shows "0". The "0" must line up with the dose pointer. You may then hear or feel a click.



- **After the dose counter has shown "0", leave the needle under the skin for at least 6 seconds** to make sure you get your full dose.

- Remove the needle from your skin.



Always inject by pressing the dose button. Do not turn it. If you turn the dose button, you will not inject insulin.

Always watch the dose counter to know how many units you inject.

Do not count the pen clicks. The dose counter will show the exact number of units.

If the dose button stops before the dose counter shows "0", the needle may be blocked. Turn the dose counter back to "0" and replace the needle with a new one. Test the insulin flow and inject your full dose.



You may see a drop of insulin at the needle tip after injecting. This is normal and does not affect your dose.

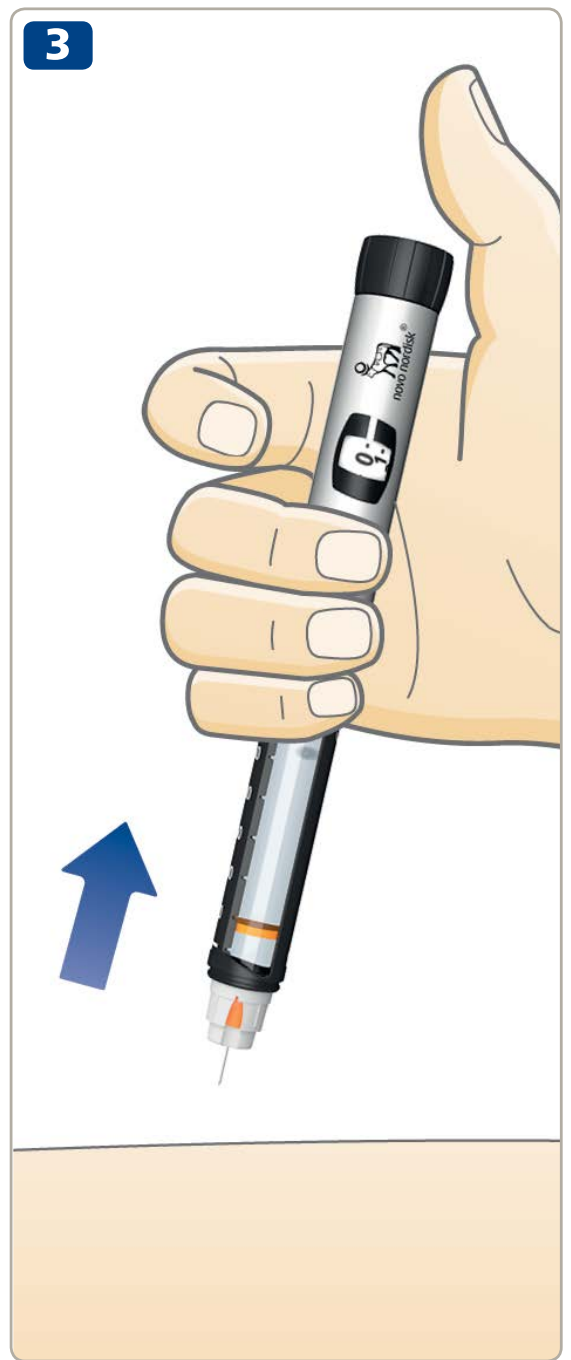

After your injection

1



- If you have a sharps container, use this to remove the needle right away.
- If you do not have a sharps container, follow a one-handed needle recapping method. **Lead the needle tip into the outer needle cap** on a flat surface without touching the needle.

2

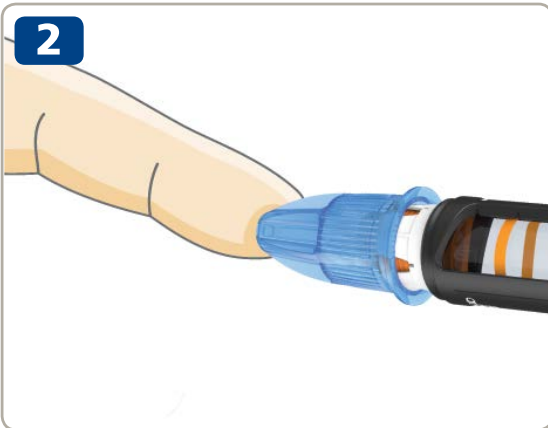

- Do not touch the outer needle cap before it covers the needle.
- Once the needle is covered, **carefully push the outer needle cap completely on.**

3



- Hold the black cartridge holder and unscrew the needle. Dispose of it carefully.



Never try to put the inner needle cap back on the needle. You may stick yourself with the needle.

- **Put the pen cap on** your pen after each use to protect the insulin from light.
- Store your pen carefully. The pen should be **out of sight and reach of others, especially children**, see page 27 on how to store the pen.

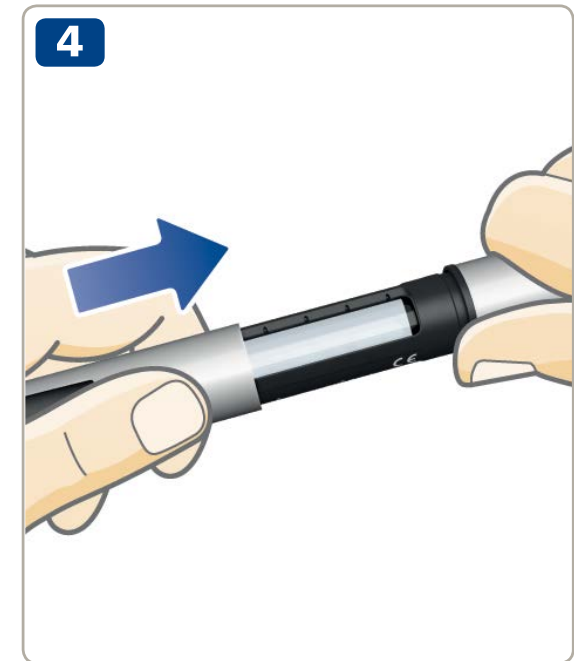

Always hold the black cartridge holder when you unscrew the needle. Otherwise you may twist your pen apart. If this happens, twist the pen together again. Replace the needle and test the insulin flow before your next injection to make sure you get your full dose.

Always remove and dispose of the needle from your pen. This reduces the risk of blocked needles, contamination, infection and inaccurate dosing. Do not store your pen with a needle attached.

What is the dose memory?

1

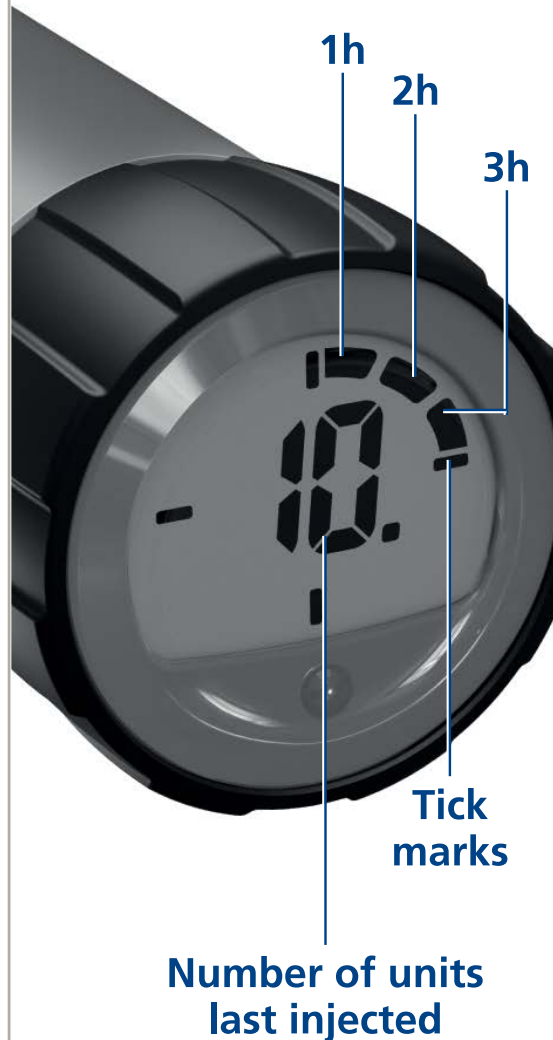

Your pen has a dose memory that **saves information about how much insulin you last injected and the time passed since then.**

The number in the dose memory display is the **number of units** last injected.

The segments around the edge show how many **full hours** have passed since your last injection. When a full hour has passed, one segment will be shown. Another segment will appear when another full hour has passed.

The four **tick marks** are always visible when the display is activated.

The example on the left shows 10 units injected more than 3 hours ago, but less than 4.

Note that **the dose memory only saves information about the last injection or insulin flow test.** If for example, you test the insulin flow with 2 units and then inject 30 units, the dose memory only saves information about the 30 units injected and the time passed since then.



The dose memory **does not tell you how much insulin you need** for your next injection. If in doubt about how much insulin you need to inject, check your blood sugar level. Otherwise, you may get too much or too little insulin.

How to read the dose memory

The examples below show you how to read the dose memory.



More than 12 hours ago

(All 12 segments shown)

10 units injected



More than 1 hour ago, but less than 2

(One segment shown)

10 units injected



Less than 1 hour ago

(No segments shown)

10 units injected

How to check your last dose

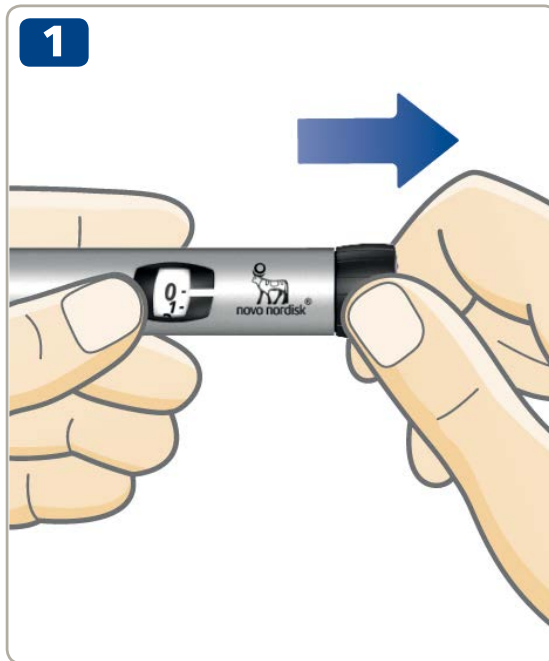

- Make sure the dose counter shows “0” before you start. The “0” must line up with the dose pointer.
- **Pull out the dose button.**
- **Push the dose button back in** to check your last dose.

First you see the test display. All display elements are shown to confirm that the display is working.

Next, the display shows the details of your last dose. After 10 seconds, it turns off.

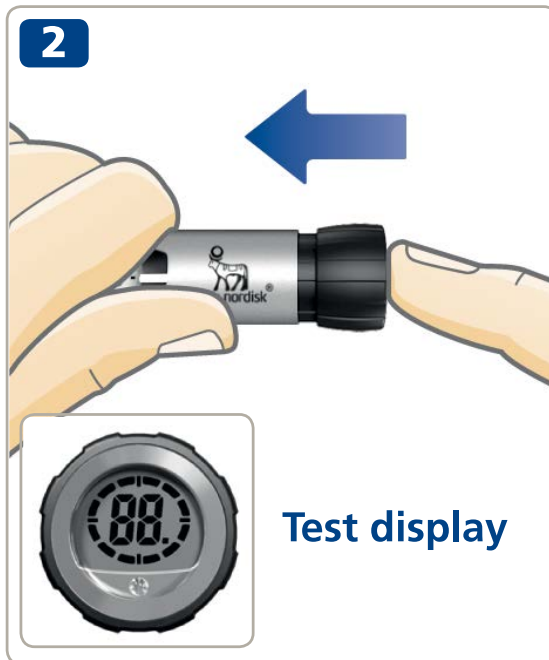

Do not turn the dose button when you check your last dose. Turning and then pushing it will overwrite the details of your last dose. If you turn the dose button by accident, simply turn it back to “0” before you push it in. This will **not** overwrite the details of your last dose.

If any of the segments on the test display are missing, the display is not working correctly. Contact your supplier to get a new pen. You can still use the pen for insulin delivery without using the dose memory.

How to check how much insulin is left

The dose counter will show exactly how much insulin is left in the cartridge, when there is less than 60 units left.

- **Turn the dose button** until it stops.
- Check the dose counter:
 - If it shows “60”: **60 units or more** are left in the cartridge.
 - If it shows less than “60”: **It is showing the number of units left** in the cartridge.
- Turn the dose button back until the dose counter shows “0”.
- Use the **insulin scale** to see **approximately** how much insulin is left in the insulin cartridge.

i If you need more insulin than the units left in the cartridge, you can split your dose between two cartridges, see page 21.



If you need more than 60 units

If you need a dose of more than 60 units, you will need to split your dose into two injections. The pen will only inject a maximum of 60 units at a time.

Example

If you need to inject 90 units:

- 1 Test the insulin flow.
- 2 Select the first dose of **60 units**.
- 3 Inject the 60 units.

To get your full dose of 90 units, **you need to inject 30 more units**.

- 4 Select the second dose of **30 units**.
- 5 Inject the 30 units.

You will now have injected the full dose of 90 units.



Be extra careful to work out your correct dose if you split it into two injections. If you split the dose wrong, you will inject too much or too little insulin. This will make your blood sugar level too low or too high.



If you split your dose into two injections, the dose memory will only save information about the second injection.

If you need more units than are left in the pen

If you need more units than you have left in the insulin cartridge, you can **split your dose between two cartridges**.

- 1** Test the insulin flow.
- 2** Find out exactly how much insulin is left and make a note of it. **Turn the dose button until it stops.** If the dose pointer points between two lines, adjust to the lower. The dose counter then shows you the number of units left in the cartridge.
- 3** Inject all the insulin left in the cartridge.
- 4** Work out how many more units you need to complete your dose.
- 5** Remove the used cartridge.
- 6** Insert and prepare a new cartridge for injection.
- 7** Test the insulin flow.
- 8** Select and inject the rest of your dose with the new cartridge.



Only if trained or advised by your healthcare professional, you may split your dose between two cartridges.

Be extra careful to work out your correct dose if you split it into two injections. If you are unsure, inject the full dose with a new cartridge. If you split the dose wrong, you will inject too much or too little insulin. This will make your blood sugar level too low or too high.



If you split your dose into two injections, the dose memory will only save information about the second injection.

How to replace a used insulin cartridge

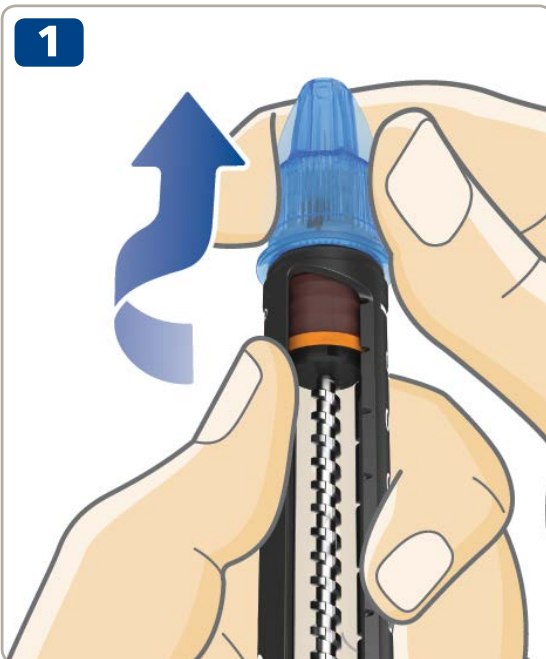

- **Remove and dispose of the needle** from your pen if the needle is still on, see *pages 14-15*.



- Twist off the cartridge holder.

- **i** When you twist off the cartridge holder, the piston rod sticks out of your pen. It may move back or forth on its own. Push it back in *as instructed on page 2*.

- Tilt the black cartridge holder and **let the cartridge slide out.** Dispose of it as your doctor or nurse has instructed you.
- Push the piston rod back in. Then **insert a new cartridge** and twist the cartridge holder back on. Attach a new needle and test the insulin flow, see pages 6-9.





Last injection not registered

The dose memory has not registered your last injection.

What to do?

Normally, the dose memory will start working again after your next injection. If not, contact your supplier to get a new pen. You can still use the pen for insulin delivery without using the dose memory.



Dose memory inactive or battery flat

The dose memory has not been activated, or the battery is flat.

What to do?

Pull out the dose button, then push it back in to activate the dose memory. If the display stays blank, the battery is flat. Contact your supplier to get a new pen. You can still use your pen for insulin delivery until you get a new one. *See page 28 for warranty information.*



Pen approaching end of life

The battery is running low, and the dose memory is approaching end of life.

What to do?

The pen will last four to five years. When the battery is running low, the message "End" will run across the dose memory display when you check your last dose.

When the battery runs flat, the dose memory will stop working and only show "End" running across the display. After a while, it turns blank. Contact your supplier to get a new pen. You can still use your pen for insulin delivery until you get a new one. *See page 28 for warranty information.*

Care

- **Only use your NovoPen® 5** as described in this guide.
- **Do not drop your pen** or knock it against hard surfaces. If you drop it or suspect a problem, check the insulin cartridge for damages, for example cracks. Replace the cartridge with a new one if necessary.
- **Keep your pen away** from direct sunlight, and do not expose it to dust, dirt or liquid.
- **Do not expose your pen** (without an insulin cartridge inserted) to temperatures below -25°C or above $+45^{\circ}\text{C}$. With an insulin cartridge inserted, please see the storage instructions in the Penfill® cartridge 3 ml leaflet that comes with the Penfill® cartridge 3 ml package.
- **Do not try to repair your pen** or pull it apart.
- The battery lasts for four to five years. For your safety it is non-replaceable. When the battery is flat, contact your supplier to get a new pen. You can still use your pen for insulin delivery without using the dose memory.

Cleaning

- **Only clean your pen** with mild detergent on a moistened cloth.
- **Do not wash, soak or lubricate your pen**, and do not use products containing bleaching agents, such as chlorine, iodine or alcohol to clean your pen. This may damage it.
- If there is insulin on the outside of your pen, **clean it before it dries up** with mild detergent on a moistened cloth.

Storage

- **Store your pen at room temperature** – with or without an insulin cartridge in the cartridge holder.
- **Do not store your pen with a needle attached.**
- **Do not freeze your pen** with an insulin cartridge inserted or store it in a refrigerator or next to a cooling element.
- **Store the insulin cartridges** as instructed in the Penfill® cartridge 3 ml leaflet. There you will also find information about expiry date. The expiry date printed on the cartridge is for unused cartridges under refrigeration. Never use the cartridge after the expiry date on the cartridge or its box.
- **Store your pen in its case** when possible.

Disposal

- **Do not throw the pen out** with your household waste.
- **Dispose of your pen as instructed by your doctor, nurse, pharmacist or local authorities.** Consider the environment when you dispose of your pen. It contains a lithium battery, electronic parts and recyclable materials. Also make sure to remove the insulin cartridge and needle before you dispose of the pen.



NovoPen® 5 comes with a 3-year guarantee, which also includes the dose memory.

If you find that your NovoPen® 5 is faulty, Novo Nordisk will replace it. Return it to your supplier for inspection within three years of receiving it. Enclose the receipt you were given when you received your NovoPen® 5.

For customers in the European Union; if, in the course of use of NovoPen® 5, you have reason to believe that a serious incident occurred, please report it to Novo Nordisk A/S and to your national authority.

The manufacturer cannot be held responsible for any problems with your NovoPen® 5 if the instructions have not been followed.

If you need your pen's LOT number, you will find it on the dose button *as shown in the diagram on the inside cover*.

NovoPen® 5, Penfill® cartridge 3 ml, NovoFine® and NovoTwist® are registered trademarks owned by Novo Nordisk A/S, Denmark.

Technical information

The CE mark on a medical device indicates that the product conforms with the provisions in the Medical Device Regulations

(EU) 2017/745. NovoPen® 5 fulfils the specification limits for dose accuracy according to ISO 11608-1. Pen-Injectors for Medical use, Part 1: Requirements and test methods.

Protection against ingress

NovoPen® 5 is marked with IP50, where:

- 5 indicates protection against harmful amounts of dust.
- 0 indicates that the device is not protected against liquid ingress.

Protection against electrical shock

Type: Internally Powered ME Equipment.

Degree: Type BF Applied Part.



Electromagnetic compatibility

Although designed to offer protection against harmful interference in a home use environment, NovoPen® 5 has electronics that radiate radio frequency (RF) energy. Interference may therefore occur under certain conditions.

Your injection is not controlled by electronics, and dose accuracy will therefore not be affected by electromagnetic disturbance.



CE
0123



For information contact:
Novo Nordisk Limited
3 City Place, Beehive Ring Road
Gatwick, West Sussex, RH6 0PA
United Kingdom
Tel: Novo Nordisk Medical Information
and Customer Care Centre
0845 600 5055

Novo Nordisk Limited
1st Floor, Block A, The Crescent Building
Northwood Business Park
Santry, Dublin 9, D09 X8W3, Ireland
Tel: 1850 665 665

Date of Issue: 2019/05

© 2019
www.novonordisk.com

Manufactured by:
Novo Nordisk (China)
Pharmaceuticals Co. Ltd.
99 Nanhai Road, TEDA
300457 Tianjin, P.R. China

For:
Novo Nordisk A/S
Novo Alle,
DK-2880 Bagsværd, DK



8-4250-01-002-3

novo nordisk®